

NEW

The highest level are high pressure, large flow and low-dropout in world.
Solenoid Operated Directional Control Valves

New Product – Solenoid Operated Directional Control Valve

Dear Sir/Madam:

Thank you for your support for long term business relationship with Seven Ocean.

It's our policy to render the best service to customers.

The following products have been released/modified since April 2016.

These model numbers are:

DSD-G02-2C-DC24-90

These models are compatible with all previous models for installation.



SEVEN OCEAN HYDRAULIC INDUSTRIAL CO., LTD.

E-mail : sales@seven-ocean.com.tw

SEVEN OCEAN(SHA)HYDRAULIC INDUSTRIAL CO.

E-mail : sales@sevenocean.com.cn

<http://www.7ocean.com>

Features

- High pressure
The highest working pressure is MPa.
The highest backpressure of oil tank is 22MPa.
Max flow is 110L/min.
- Low pressure drop
Optimal spool design could reduce the generation of fluid force and 10% pressure drop, compared to other similar products.
- Small-sized And Compact
Assembling dimension is smaller and more compact. The length is shortened by 6% and the weight is reduced by 7%.
- Stable And Reliable operation
Five troughs design, low switch sound, long service life, stable performance.
- With IP67 high dust resistance & water resistance.
- Standard valve size: ISO.



DSV-G02-※※-A※-90



DSD-G02-※※-D※-90



DSD-G02-※※-D※-90-DT04



DSV-G02-※※-A※-90-M12A

Specifications

Max Flow		110 L/min
Max Pressure		35 MPa
Max Backpressure		22 MPa
Working Temperature		-15°C~50°C
Media Temperature Range		-15°C~70°C
Media Viscosity Working Range		15~400mm ² /s
Working Media		ISO VG 32,46
Filtration Accuracy		NAS Class 9MAX
Protective Performance		IEC 144 Class IP67
Highest Commutation Frequency		300 times/min(AC/DC) 120 times/min(RF)
Mounting Surfaces		ISO 4401-AB-03-4-A
Weight	Single Solenoid	1.65Kg(DC,RF);1.35Kg(AC)
	Double Solenoid	2.05Kg(DC,RF);1.75Kg(AC)
Fastening Screws	Metric	M5X45L (4PCS)
	Inch	10#~20UNC X1-3/4" (4PCS)
Fastening Torque		5~7 Nm

DSV-G02-90

Ordering Code:

DSV- G 02- 2C- DC24 - 90 - LS- ☒ - ☒

1
2
3
4
5
6
7
8
9
10

1 Solenoid Operated Directional Control Valve

- DSV: Wiring housing with G1/2 thread and indicator light
- DSD: DIN 43650 coils

2 Manifold Sub-plate Mounting

3 Normal Valve Size : NG 6

- ISO-4401 / CETOP-3 (NFPA-D03 / DIN 24340 (NG 6))

4 Type Of Spool (Center Condition)

- 0 : Open center (All ports)
- 1 : Open center (P.A to T)
- 2 : Closed center (All ports)
- 3 : Closed center (P.B)
- 5 : Closed center (T.B)
- 6 : Closed center (P only)
- 7 : Open center (P to A.B)
- 8 : Tandem center (P to T)
- 11 : Open center (P.B to T)
- 22 : Closed center (Two way)
- 31 : Closed center (P.A)
- 33 : Closed center (Bleed A. B)

0C	1C	2C	3C	5C	6C	7C	8C
11C	31C	33C	0A	2A	6A	22A	2N

5 Spring Cracking Pressure

- A: Spring offset to port "A" single solenoid
- AL: Spring offset to port "B" single solenoid
- B: Spring centered-single solenoid
- BL: Spring centered-single solenoid
- C: Spring centered-double solenoid
- N: Without spring with detent

6 Electric Power Source Indication

- A110: AC110V,50HZ
- A220: AC220V,50HZ
- A100: AC100V,50HZ/60HZ
- DC12: DC12V
- DC24: DC12V
- R110: AC110V,50HZ (Rectifier built-in type)
- R220: AC220V,50HZ (Rectifier built-in type)

7 90: Design number

8 LS: Surge killer ★1

9 No sign: Standard type S: No impact type ★2 F:Fast response type ★3

10 Special Electrical Options

- No sign: Standard type
- DT04: Waterproof pin type
- M12A: A side, M12-4P
- M12B: B side, M12-4P

★1 F or DSD type.
DSV: Within in box.

★2 For DC type.
Without impact type,
choose the rectifier built-in type.

★3 4 For DC type.

Notes:) You can choose the suitable valve, please confirm the delivery time before you purchase.

DSV-G02-90

Spool Types

Position type at neutral	Double solenoid valves, spring centered - C -	Single solenoid valves, solenoid at port A end - B -	Single solenoid valves, solenoid at port B end - BL -	Position type at neutral	Double solenoid valves, spring centered - C -	Single solenoid valves, solenoid at port A end - B -	Single solenoid valves, solenoid at port B end - BL -
0				6			
* 1				7			
2				8			
3				* 11			
* 5				31			
				33			

Position type at neutral	Double solenoid valves, spring centered - N -	Single solenoid valves, solenoid at port A end - A -	Single solenoid valves, solenoid at port B end - AL -	Position type at neutral	Double solenoid valves, spring centered - N -	Single solenoid valves, solenoid at port A end - A -	Single solenoid valves, solenoid at port B end - AL -
* 0				* 6			
2				* 7			
22							

Notes:) ★ You can choose the suitable valve, please confirm the delivery time before you purchase.

Features Of Electro-magnetic Coil:

Solenoid Classification	Power Source	Voltage (V)	Frequency (Hz)	Inrush Current (A)	Holding Current (A)	Holding Power (W)	Permissible Voltage (V)	Insulation Grade	Coil Insulation Class	Insulation Resistance
AC	A110	110	50	>2	<0.6	≤25	100~120	B	H (180°C)	>50
			60	>2	<0.43	≤25	100~120			
	A220	220	50	>2.4	<0.3	≤25	210~230			
			60	>2	<0.3	≤26	210~230			
	A100	100	50	>2	<0.5	≤26	90~110			
			60	>2	<0.5	≤26	90~110			
	A120	110	50	>2	<0.6	≤25	100~120			
			120	60	>2	<0.55	≤25			
A240	220	50	>2.4	<0.3	≤26	210~230				
		240	60	>2	<0.35	≤25	230~250			
DC	DC12	12	-	-	<2.6	<30	11~13			
	DC24	24	-	-	<1.3	<30	22~26			

DSV-G02-90

List of Standard Models (Standard)

Note: Max flow indicates a ceiling flow depends on the type of spool and operating condition.

Spool-Spring Arrangement	ISO Graphic Symbols			Voltage	Pressure - Flow Characteristic		
	Double solenoid valves, spring centered -C-	Single solenoid valves, solenoid at port A end -B-	Single solenoid valves, solenoid at port B end -BL-				
Spring Centred	DSV-G02-2C 	DSV-G02-2B 	DSV-G02-2BL 	AC	①	⑧	⑧
				DC	①	⑧	⑧
	DSV-G02-0C 	DSV-G02-0B 	DSV-G02-0BL 	AC	①	④	④
				DC	①	④	④
	DSV-G02-6C 	DSV-G02-6B 	DSV-G02-6BL 	AC	②	⑧	⑧
				DC	②	⑧	⑧
	DSV-G02-33C 	DSV-G02-33B 	DSV-G02-33BL 	AC	③	④	④
				DC	③	④	④
	DSV-G02-8C 	DSV-G02-8B 	DSV-G02-8BL 	AC	⑤	⑤	⑤
				DC	⑤	⑤	⑤
	DSV-G02-7C 	DSV-G02-7B 	DSV-G02-7BL 	AC	①	⑦	⑦
				DC	①	⑦	⑦
	DSV-G02-31C 	DSV-G02-31B 	DSV-G02-31BL 	AC	①	⑧	⑧
				DC	①	⑧	⑧
	DSV-G02-5C 	DSV-G02-5B 	DSV-G02-5BL 	AC	①	⑦	⑧
				DC	①	⑦	⑧
	DSV-G02-3C 	DSV-G02-3B 	DSV-G02-3BL 	AC	①	⑧	⑧
				DC	①	⑧	⑧
	DSV-G02-1C 	DSV-G02-1B 	DSV-G02-1BL 	AC	②	⑥	④
				DC	②	⑥	④
DSV-G02-11C 	DSV-G02-11B 	DSV-G02-11BL 	AC	②	④	⑥	
			DC	②	④	⑥	

DSV-G02-90

List of Standard Models (Standard)

Note: Max flow indicates a ceiling flow depends on the type of spool and operating condition.

Spool - Spring Arrangement	ISO Graphic Symbols			Voltage	Pressure - Flow Characteristic		
	Double solenoid valves, spring centered - N -	Single solenoid valves, solenoid at port A end - A -	Single solenoid valves, solenoid at port B end - AL -				
Spring Offset	DSV-G02-2N 	—	—	AC	③	⑤	⑤
	—	DSV-G02-2A 	DSV-G02-2AL 	AC	③	⑦	④
	—	DSV-G02-0A 	DSV-G02-0AL 	AC	④	⑤	④
	—	DSV-G02-22A 	DSV-G02-22AL 	AC	—	⑦	④
	—	—	—	DC	③	⑤	⑤
	—	—	—	DC	③	⑦	④
	—	—	—	DC	④	⑤	④
	—	—	—	DC	④	⑤	④

Pressure - Flow Characteristic

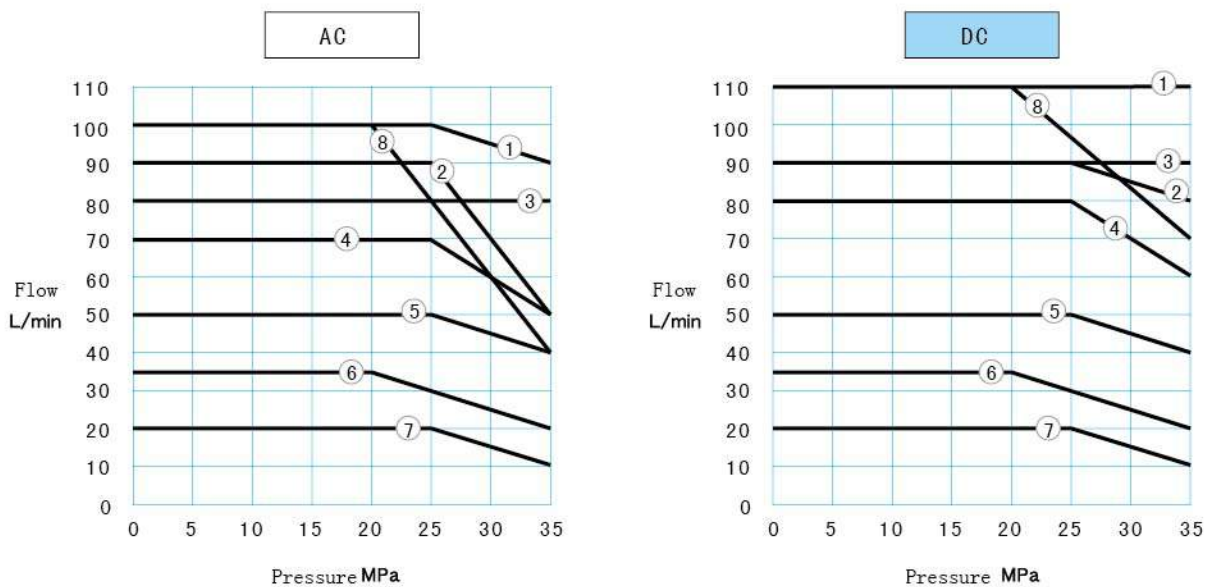

Note: The relationship between with the max flow, frequency and voltage are show in the drawing.

AC: 90% V (50HZ) (After coil temperature rises and saturated)

DC: 90% V (After coil temperature rises and saturated)

DSV-G02-90

Max flow, P port to T port

In the valve type 8C, if the actuator is placed between the cylinder ports A and B as illustrated below, the actuator moves and suspends at its stroke end, and the valve is then shifted to the neutral position with the actuator suspended, the maximum flow rates available are those shown below regardless of the voltage in the serviceable voltage range.

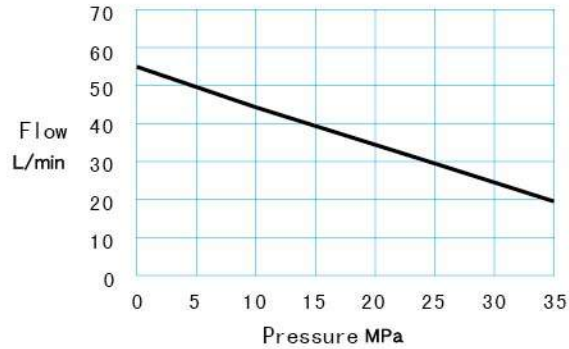
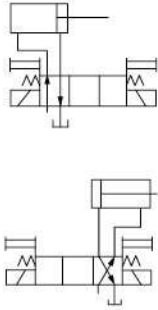

Changeover Time

Changeover time varies according to the oil viscosity, spool type, and hydraulic circuit.

Unit: ms

Voltage	Operation	De-energize Time	Spring Centered	Spring Offset	No Spring Detented
			C, B, BL	A, AL	N
AC	Energize	/	10 ~ 15		10 ~ 15
	Spring Return		20	—	
DC	Energize		30	30	
	Spring Return		15	—	
AC→DC conversion	Energize		30	30	
	Spring Return		Fast	20	—
Slow		90	—		

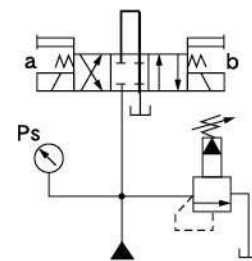

Pressure: 17.5 MPa
Flow: 40 L/min
Viscosity: 20 mm²/s

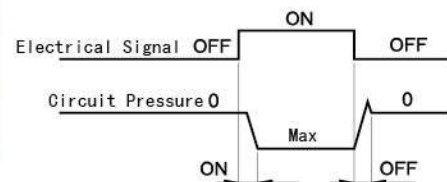

DSV-G02-90

Pressure Drop

Pressure drop curves based on a viscosity of 35 mm²/s and a specific gravity of 0.850.

Standard type

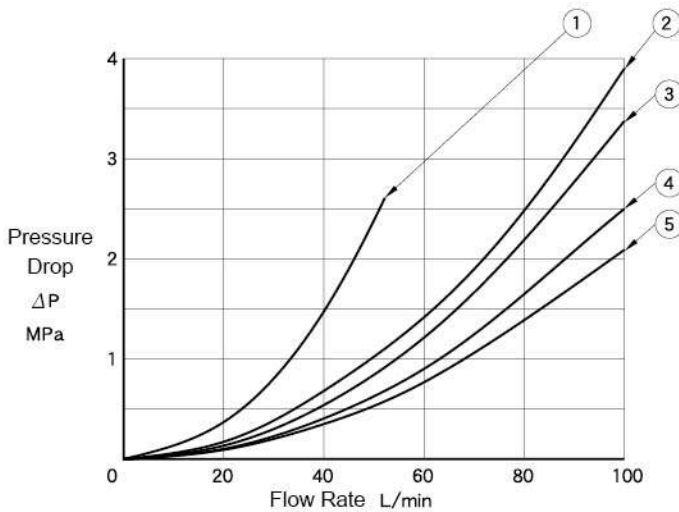

Model	Pressure Drop Curve Number				
	P→A	B→T	P→B	A→T	P→T
DSV-G02-2C	④	④	④	④	—
DSV-G02-0C	⑤	⑤	⑤	⑤	②
DSV-G02-6C	④	④	④	④	—
DSV-G02-33C	④	④	④	④	—
DSV-G02-8C	①	①	①	①	②
DSV-G02-7C	⑤	③	⑤	③	—
DSV-G02-31C	④	⑤	④	④	—
DSV-G02-5C	④	④	④	④	—
DSV-G02-3C	④	④	④	⑤	—
DSV-G02-2N	⑤	④	⑤	④	—
DSV-G02-2A	⑤	④	⑤	④	—
DSV-G02-0A	⑤	⑤	⑤	⑤	—
DSV-G02-22A	⑤	—	④	—	—

Without compact type DSV-G02-※-S

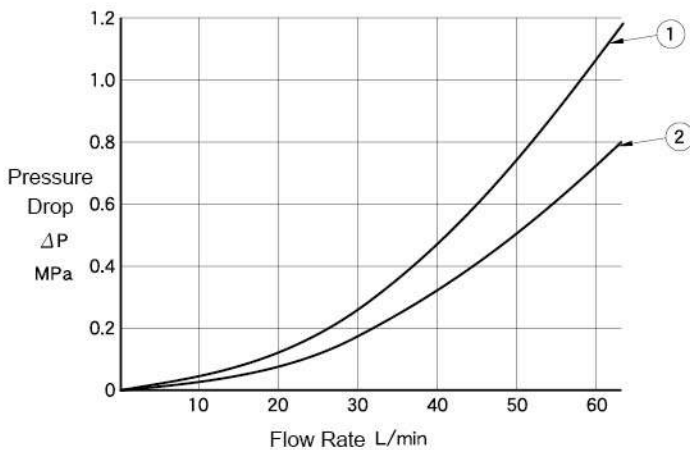

Model	Pressure Drop Curve Number			
	P→A	B→T	P→B	A→T
DSV-G02-2C-※-S	①	①	①	①
DSV-G02-6C-※-S	①	②	①	②
DSV-G02-2A-※-S	①	①	①	①

For any other viscosity, multiply the factors in the table below.

Viscosity	mm ² /s	15	20	30	40	50	60	70	80	90	100
		SSU	77	98	141	186	232	278	324	371	417
Factor		0.81	0.87	0.96	1.03	1.09	1.14	1.19	1.23	1.27	1.30

For any other specific gravity (G'), the pressure drop (ΔP') may be obtained from the formula below. $\Delta P' = \Delta P(G'/0.850)$

Mounting surface: ISO4401-AB-03-4-A

DSV-G02-90

- The voltage type is A* (Wiring housing with G1/2 thread and indicator light)
- Spring Centred / No-spring Detented

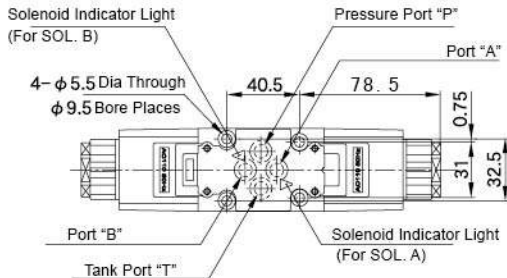

- Spring Offset.

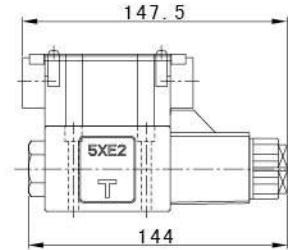

- For other dimensions, refer to the left figure.
- A model with the solenoid mounted on the SOL a side (reverse mounting) is also available.

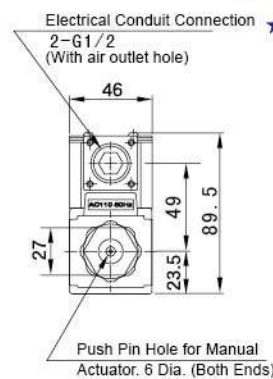
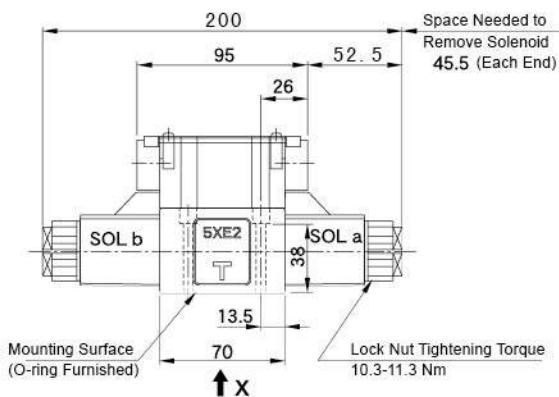

- ★ Locating pin can be fitted to this hole to conform with ISO 4401-03-02-0-94. However, no locating pin is provided to a standard design valve. When ordering a valve with a locating pin, consult Seven Ocean.

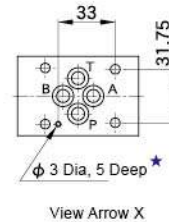

- The voltage type is DC*. DSV-G02-※※-DC※
- The voltage type is R*. (Wiring housing with G1/2 thread and indicator light)
- Spring Centred / No-spring Detented/ Spring Offset

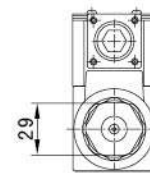
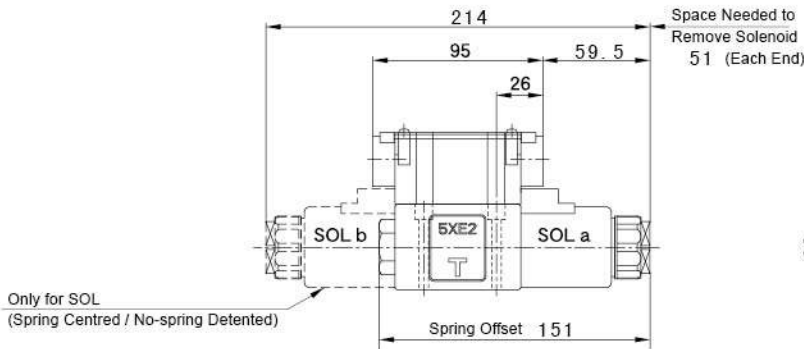

- For other dimensions, refer to the upper figure.

- Wiring box matches with M12-4P terminal
- Spring Centred / No-spring Detented/ Spring Offset

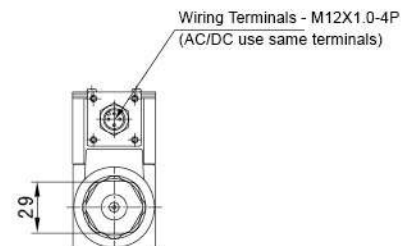
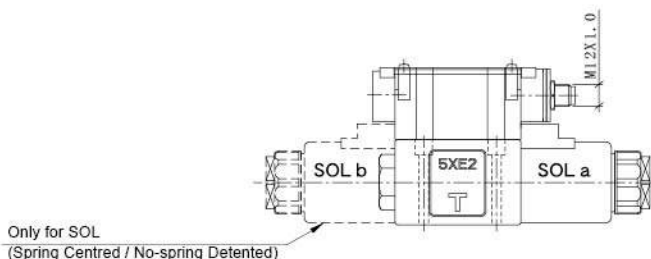

■ Plug-in Connector

- The voltage type is A*
- The voltage type is DC*
- The voltage type is R*

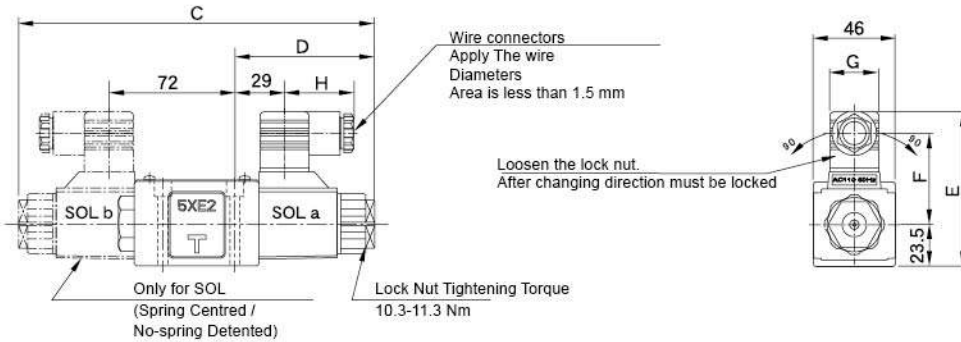

Model	C	D	E	F	G	H
DSD-G02-※※-A※-DN-※	200	78.5	89	53.5	27.5	39
DSD-G02-※※-DC※-DN-※-(S)	214	85.5	87	51.5	27.5	39
DSD-G02-※※-R※-DN-※	214	85.5	87	51.5	27.5	39

● Please see the junction WB type other sizes.

■ BOM for Seals and Solenoid Valves

DSV-G02-※※-DC※-(S)

Spring Offset Type

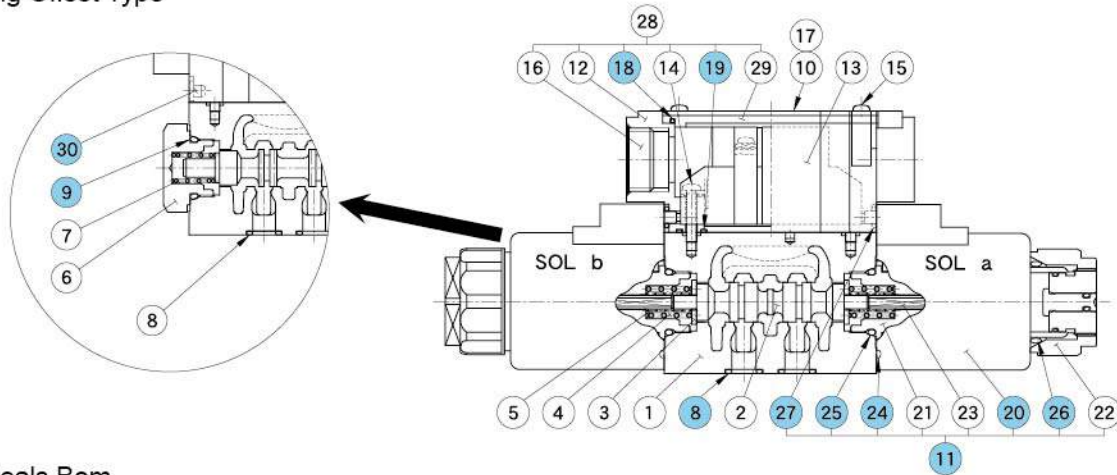



● Seals Bom

Item	Name of Parts	Part Numbers	Qty.			Remarks
			※C	※N	※A/B	
8	O-ring	P9 (NBR, Hs90)	4	4	4	
9	O-ring	P18 (NBR, Hs90)	—	—	1	
18	Packing	—	1	1	1	Including in wiring box.
19	O-ring	EKM Φ5.5*Φ1.5 (NBR, Hs70)	2	2	2	Including in solenoid valve
24	O-ring	EKM Φ38*Φ1.8 (NBR, Hs70)	2	2	1	
25	O-ring	P18 (NBR, Hs90)	2	2	1	
26	O-ring	EKM Φ22.4*Φ3.1 (NBR, Hs70)	2	2	1	
27	O-ring	P4 (NBR, Hs70)	4	4	2	
30	Plastics Plug	—	—	—	2	Including in wiring box.

DSV-G02-90

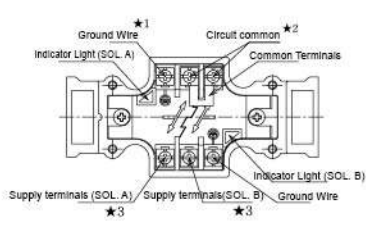
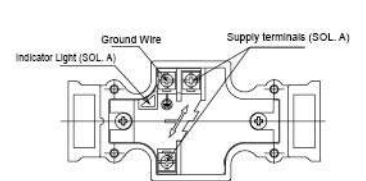
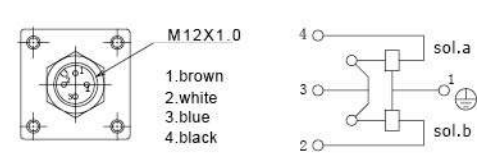
- Connection Methods
- Graphic Symbol Of Terminal.

Wiring Box Type	Double Solenoid Valve Type
	
	Single Solenoid Valve Type (A side)
	
	Double Solenoid Valve Type
	
Single Solenoid Valve Type (A side)	
	

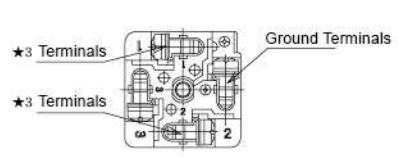
Single Solenoid Valve	
Plug-in Connector Type	

- ★ There are two ground wire and can use any one.
- ★ Don't need common terminals which can be dismantle.
- ★ DC solenoid valve is polarity-independent.