

WET TYPE SOLENOID OPERATED DIRECTIONAL CONTROL VALVES

MAX. FLOW OF NG6/D03: 100 ℓ/MIN.
MAX. FLOW OF NG10/D05: 160 ℓ/MIN.
MAX. HIGH PRESSURE: 350BAR
MAX. BACK PRESSURE: 210BAR

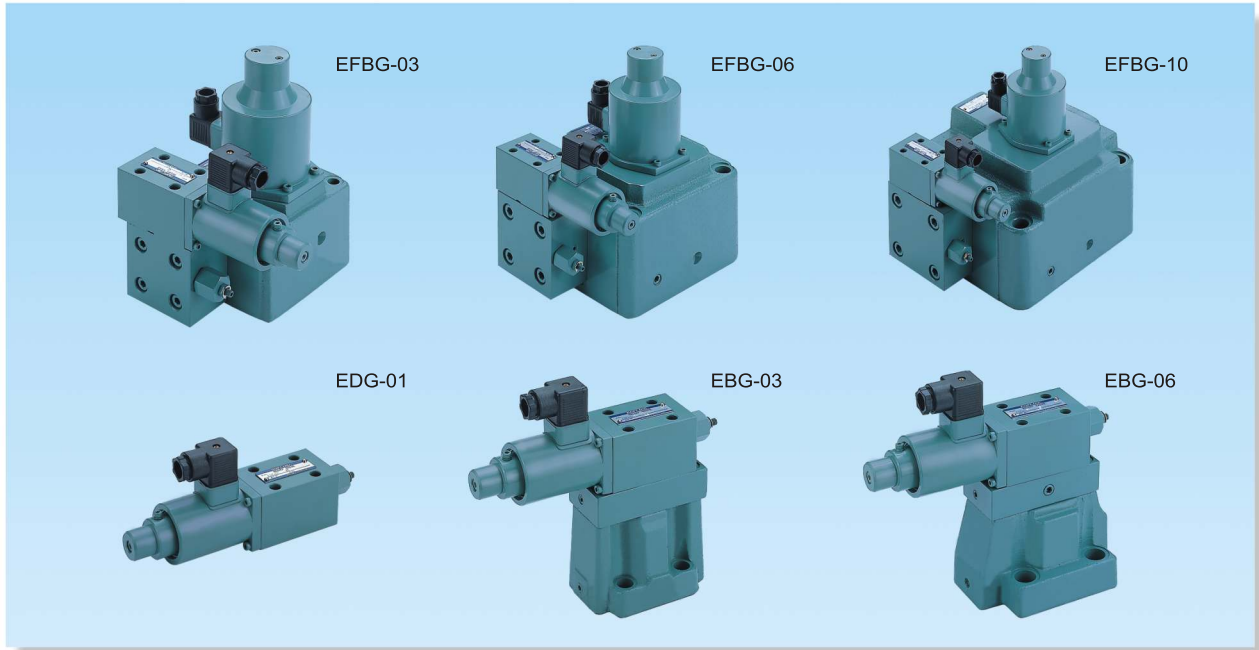

ELECTRO HYDRAULIC PROPORTIONAL VALVES



SOLENOID OPERATED DIRECTIONAL VALVES

DFA-02-✕-AC/DC✕-✕-35(35C)



DFA-03-✕-AC✕-✕-35



DFA-03-✕-AC✕-✕-35H



DFB-02-✕-AC/DC✕-✕-35(35C)



DFB-03-✕-AC✕-✕-35



DFB-03-✕-AC✕-✕-35H

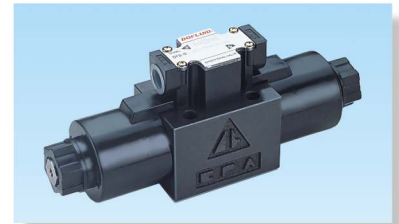

DFA-02-✕-DC✕-✕-35



DFA-03-✕-DC✕-✕-35



DFA-03-✕-AC✕-✕-35H



DFB-02-✕-DC✕-✕-35



DFB-03-✕-DC✕-✕-35



DFB-03-✕-DC✕-✕-35H



Wet Type (Oil Immersed) Solenoid

- Max. high pressure of 35 MPa (5,000 psi) & Max. high flow capacity of 160 ℓ/min (42 gpm).
- Oil immersed armature provides stable, quiet operation-even under high pressure & high cycle frequency, allowing for longer valve life.
- Valve mounting accomplished without disturbing valve nameplate or electrical box.
- High tank port back pressure upto 21 MPa/3040 psi (check each spool type for max. allowable).
- Shockless type coils are available-reducing voltage spikes, providing even quieter operation and extending relay contact life.
- Twin tank line design greatly reduces both pressure drop and system operating cost.

Joint Box/plug-In Coils

- Large electrical box supplied standard, with indicator lights and terminal strip including earth ground terminal.
- Simple design allows easy assembly and dismantling.
- Coils can be easily replaced without disturbing wiring and without risk of oil leakage.

Lead Wire Coils

- Lead wire coils available popular with the mobile industry.
- Single spade DC coil also available for one wire "spade" connection.

DIN Coils

- Manufactured to accept standard 3 pin DIN 43 650 and ISO 4400 connectors.
- AC coils are rated for both 50/60 Hz service-rewiring not required if switching frequencies.
- DC coils are not polarity sensitive.

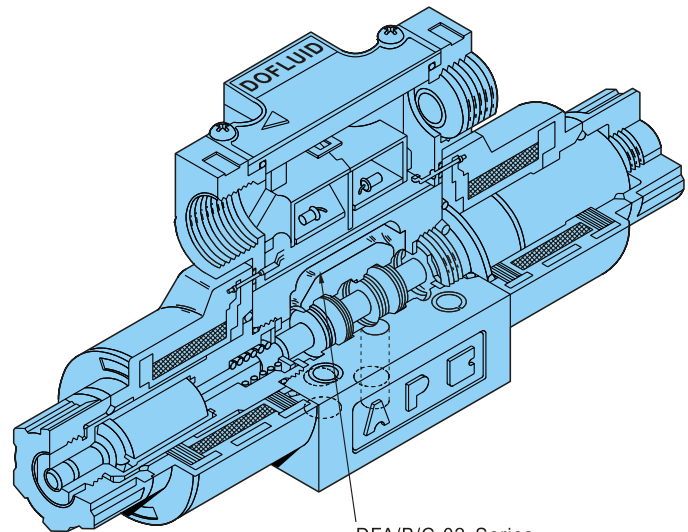

DFA/B/C-02 Series
• With both upper & lower return line ports (to T port)

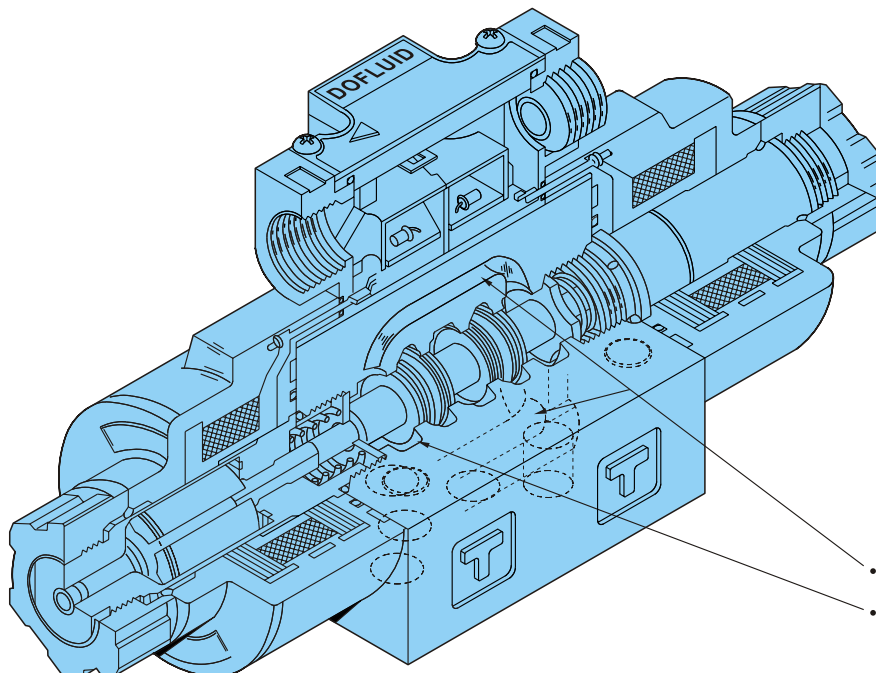

DFA/B/C - 03 Series
• With both upper & lower return line ports (to T port)
• With special 5 channels and 6 teeth

DIN Connector

Conforms to standard 3 pin DIN 43 650 and ISO 4400 standard connectors. Clear lighted connectors are supplied standard for AC coils-optional lighted connectors available for DC coils.

AC Solenoid

50-60 Hz common service solenoids do not require re-wiring when the applied frequency is changed.

Electric Shockless

AC coils can be provided with optional RAC type to include rectified coils that convert AC to DC- this reduces voltage spikes, provides even quieter operation and extends relay contact life. Coil heat generation is much less in holding applications when using rectified coils. The rectifier is supplied either in the electrical box or provided in the DIN connector.

Hydraulic Shockless

Valves can be provided with option S to slow the shifting of the spool. Oil is metered as the armature moves in the large core tube causing increased shifting times, up to 4 times normal (depending on temperature). Note : AC valves are always supply rectified to DC valve. Shockless valves will not operate as shockless until tank line has become filled with oil-this will occur automatically after a first few cycles.

Other Notice

Pressure ratings are reduced for the tank port-check each of spool types for maximum allowable pressure (including pressure spikes). Do not supply-electric power to the AC solenoid unless the coil is mounted to the valve. Electrical power should be maintained on detented valves when in operation-the detent only maintains the valve start-up condition. When plumbing valves for 1 way or 2 way operation-flow should be limited and unused ports should be plugged (do not plug the tank port on models 2B8, 2B8L, 2D8). Do not exceed voltage specifications shown in the catalog.

Variety

There are various kinds of solenoid directional valves for your selection, which with different sizes of 1/4 & 3/8", different AC or DC solenoid, different wiring of joint box type or DIN (hirschmann) type, different spool types, with or without shockless type etc.

Fluid Types Recommended

1. Petroleum based mineral oil (conform to ISO VG 32 & 46)
2. Phosphate-esters based hydraulic oil.
3. Water-glycol group hydraulic oil.

Fluid Temperature Range

From +5°C to +60°C(41°F - 140°F) recommended







Fluid Viscosity Range

15-310 cSt (80-1400 SSU) recommended

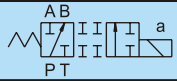
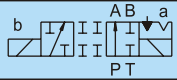
Contamination Control

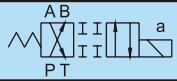
Fluid contamination should be kept at/above NAS 1638-12 class and adopt filtration of 25µm or even better filtration, otherwise, valves are easily to be damaged or shorten life.

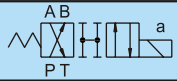
SPECIFICATIONS

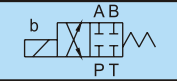
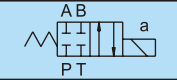
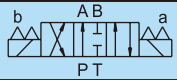
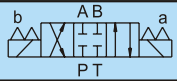
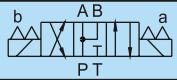
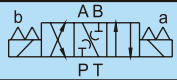
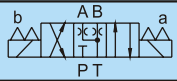
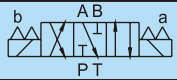
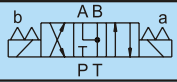
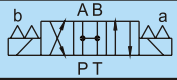
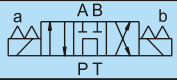
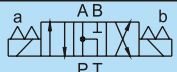









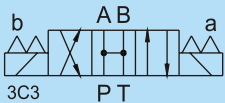
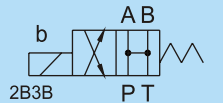
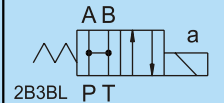

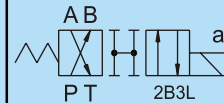
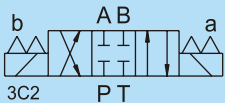
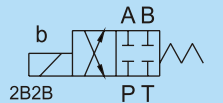
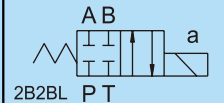

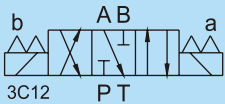
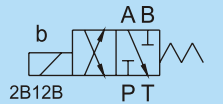
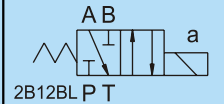
Model		DFA/B/C - 02 - 35(C) Series				DFA/B/C - 03 - 35(H) Series																
		Standard type		Shockless type		Standard type				Shockless type												
		Symbol	Valve spool type	Max. operating pressure MPa (psi)	Max. flow ℓ /min (gpm)	Max. operating pressure MPa (psi)	Max. flow ℓ /min (gpm)	AC				DC & RAC										
Max. operating pressure MPa (psi)	Max. flow ℓ /min (gpm)							Max. operating pressure MPa (psi)	Max. flow ℓ /min (gpm)	Max. operating pressure MPa (psi)	Max. flow ℓ /min (gpm)											
	2B8	35 (5070)	30 (7.9)	30 (7.9)	35 (5070)	35 (5070)	35 (5070)	35 (5070)	35 (5070)	25 (3620)	50 (13.5)	130 (34.3)	160 (42.3)	130 (34.3)								
	2B8L														40 (10.6)	85 (22.5)	85 (22.5)					
	2D8														85 (22.5)	85 (22.5)						
	2B2														80 (21.1)		100 (26.4)					
	2B2L														65 (17.1)							
	2D2															100 (26.4)						
	2B3														65 (17.1)	100 (26.4)	25 (3620)	50 (13.5)	130 (34.3)	160 (42.3)	130 (34.3)	
	2B3L																					
	2D3																					
	2B2B														100 (26.4)	50 (13.2)	40 (10.6)	25 (3620) 35 (Specified)	70 (18.5)	25 (3620) 35 (Specified)	100 (26.4)	85 (22.5)
	2B2BL																					
	3C11																					
	3C2																					
	3C9																					
	3C41																					
	3C40																					
	3C12	AC: 65 (17.1) DC: 80 (21.1)																				
	3C4																					
	3C3																					
	3C60	25 (3620) 35 (Specified)	50 (13.2)	40 (10.6)	25 (3620) 35 (Specified)	70 (18.5)	25 (3620) 35 (Specified)	100 (26.4)	85 (22.5)													
	3C5	25 (3620) 35 (Specified)	50 (13.2)	40 (10.6)	25 (3620) 35 (Specified)	70 (18.5)	25 (3620) 35 (Specified)	100 (26.4)	85 (22.5)													

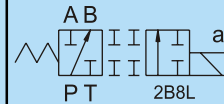
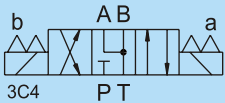
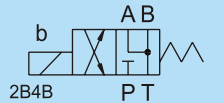
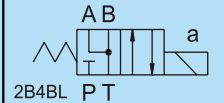
		DFA/B/C - 02			DFA/B/C - 03		
		AC solenoid	DC solenoid		AC solenoid	DC solenoid	
			Built-in rectifier			Built-in rectifier	
		AC ✕	RAC ✕	DC ✕	AC ✕	RAC ✕	DC ✕
Max. operating pressure	P, A, B ports	35 MPa (5070 psi) (Note 1)					
Max. permissible back pressure	T port	35:21 MPa (3040 psi) 35C:16 MPa (2320 psi)			16 MPa (2320 psi)		
Changeover frequency (times/min)	Standard type	300	120	300	300	120	240
	Shockless type	—	—	120	—	—	120
Standard	Indicator light	L (Note 2)					
	Shockless	—	S	—	S	—	
Mass kg (lbs)	Double solenoids	1.8 (4.0)	2.0 (4.4)	—	4.2 (9.2)	5.0 (11)-35	5.6 (12.3)-35H
	Single solenoid	1.4 (3.1)	1.5 (3.3)	—	3.6 (7.9)	3.9 (8.6)-35	4.2 (9.2)-35H
Recommended operating conditions	Operating temperature range	-20 ~ 70 °C (-4 ~ 158 °F)			5 ~ 60 °C (41 ~ 140 °F)		
	Operating viscosity	15 ~ 300 mm ² /s (80 ~ 1400 SUS)					
	Viscosity index	90 or above					
	Filtration	25 μm or less					

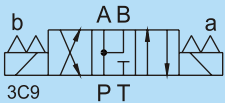
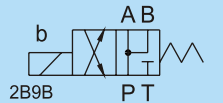
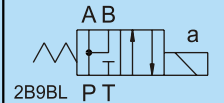
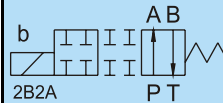
Note 1) Max. operating pressure differs depending on the valve type.

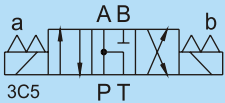
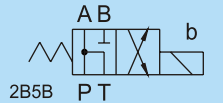
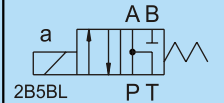
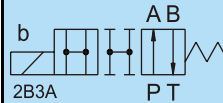
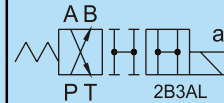
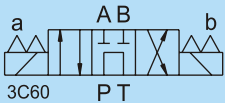
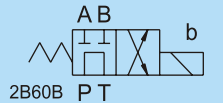
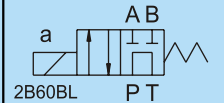
2) DFA: "L" is not standard.

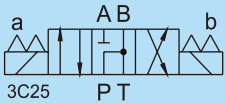
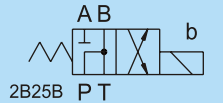
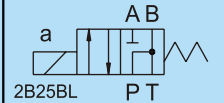
SYMBOLS

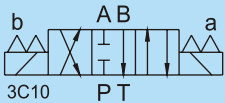
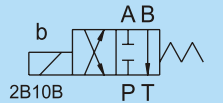
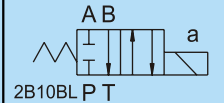
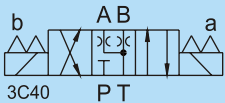
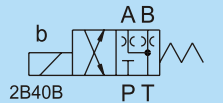
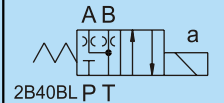
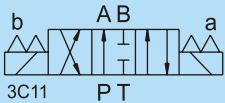
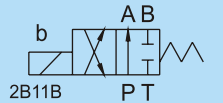
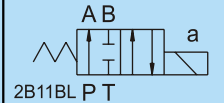
Solenoid specifications

Solenoid classification		AC solenoid											
Power source		C1 / C3			C120		C2 / C4			C5 / C6			
Voltage(V)		AC110		AC120	AC120		AC220		AC240	AC240			
Frequency(Hz)		50	60	60	50	60	50	60	60	50	60		
Size 02	Solenoid coil type	DFA-02-35		2AH-C1/C3			2AH-C120		2AH-C2/C4			2AH-C5/C6	
		DFB-02-35		2BH-C1/C3			2BH-C120		2BH-C2/C4			2BH-C5/C6	
	Starting current(A)		2.2	2.0	2.2	2.0	1.8	1.1	1.0	1.1	1.0	0.9	
	Holding current(A)		0.54	0.41	0.47	0.45	0.35	0.25	0.19	0.23	0.23	0.18	
	Holding electric power(W)		25	22	28	25	22	25	22	28	25	22	
	Permissible voltage range(V)		80 ~ 120			90 ~ 130		180 ~ 240			200 ~ 260		
	Insulation resistance(MΩ)		100 or above (500V)										
Size 03	Solenoid coil type	DFA-03-35		3AH-C1/C3			3AH-C120		3AH-C2/C4			2AH-C5/C6	
		DFB-03-35		3BH-C1/C3			3BH-C120		3BH-C2/C4			2BH-C5/C6	
	Starting current(A)		5.5	4.6	5.0	5.0	4.2	2.7	2.3	2.5	2.5	2.1	
	Holding current(A)		1.1	0.86	1.0	0.9	0.71	0.52	0.42	0.48	0.4	0.33	
	Holding electric power(W)		36	34	42	36	34	36	34	32	36	34	
	Permissible voltage range(V)		80 ~ 120			90 ~ 130		180 ~ 240			200 ~ 260		
	Insulation resistance(MΩ)		100 or above (500V)										

Solenoid classification		DC solenoid							
Power source		Built-in rectifier				D1	D2		
Voltage(V)		R1 / R3		R2 / R4		DC1 2	DC24		
Frequency(Hz)		50 / 60		50 / 60		—	—		
Size 02	Solenoid coil type	DFA-02-35		2AF-R1/R3		2AF-R2/R4		2AF-D1	2AF-D2
		DFB-02-35		2BF-R1/R3		2BF-R2/R4		2BF-D1	2BF-D2
	Current(A)		0.31	0.32	0.15	0.16	2.5	1.25	
	Holding electric power(W)		30	32	30	32	30	30	
	Permissible voltage range(V)		80 ~ 130		180 ~ 250		10.8 ~ 13.2	21.6 ~ 26.4	
	Insulation resistance(MΩ)		100 or above (500V)						
Size 03	Solenoid coil type	DFA-03-35		3EA-R1/R3		3EA-R2/R4		3EA-D1	3EA-D2
		DFB-03-35		3EB-R1/R3		3EB-R2/R4		3EB-D1	3EB-D2
	Current(A)		0.46	0.49	0.22	0.24	3.0	1.5	
	Holding electric power(W)		31	34	30	33	31	36	
	Permissible voltage range(V)		80 ~ 130		180 ~ 250		10.8 ~ 13.2	21.6 ~ 26.4	
	Insulation resistance(MΩ)		100 or above (500V)						

Solenoid classification		AC solenoid											
Power source		C1 / C3			C120		C2 / C4			C5 / C6			
Voltage(V)		AC110		AC120	AC120		AC220		AC240	AC240			
Frequency(Hz)		50	60	60	50	60	50	60	60	50	60		
Size 03	Solenoid coil type	DFA-03-35H		3EA-C1/C3			3EA-C120		3EA-C2/C4			3EA-C5/C6	
		DFB-03-35H		3EB-C1/C3			3EB-C120		3EB-C2/C4			3EB-C5/C6	
	Starting current(A)		5.3	4.5	5	5	4.2	2.6	2.2	2.4	2.5	2.1	
	Holding current(A)		1.1	0.9	1.0	1.1	0.87	0.56	0.45	0.53	0.47	0.38	
	Holding electric power(W)		36	34	42	36	34	36	34	32	36	34	
	Permissible voltage range(V)		80 ~ 120			90 ~ 130		180 ~ 240			200 ~ 260		
	Insulation resistance(MΩ)		100 or above (500V)										

Solenoid classification		DC solenoid							
Power source		Built-in rectifier				D1	D2		
Voltage(V)		R1 / R3		R2 / R4		DC12	DC24		
Frequency(Hz)		50 / 60		50 / 60		—	—		
Size 03	Solenoid coil type	DFA-03-35H		3AF-R1/R3		3AF-R2/R4		3AF-D1	3AF-D2
		DFB-03-35H		3BF-R1/R3		3BF-R2/R4		3BF-D1	3BF-D2
	Current(A)		0.42	0.46	0.21	0.23	3.2	1.6	
	Holding electric power(W)		31	34	30	33	30	30	
	Permissible voltage range(V)		80 ~ 130		180 ~ 250		10.8 ~ 13.2	21.6 ~ 26.4	
	Insulation resistance(MΩ)		100 or above (500V)						

S-DFA/B/C-02-※-AC/DC ※ -※-35(35C)

DFA/B/C-03-※-AC※-※-35

DFA/B/C-03-※-AC※-※-35H

S-DFA/B/C-02-※-DC※-※-35

S-DFA/B/C-03-※-DC※-※-35

S-DFA/B/C-03-※-DC※-※-35H

ORDERING CODE
S - DF - A - 02 - 3C2 - A110 - L - 35C - 00

Manufacturing year

 02: 2002
03: 2003

 Designing number for high pressure
& high flow type:

 35: Permissible back pressure 210bar
35H: Specially specified
35C: Permissible back pressure 160bar
(only for size 02)

L: With indicating light

No code: Without indicating light

Coil voltage:

 AC: A110(50/60Hz) & A120(60Hz)=C1/C3
A120(50/60Hz)=C120
A220(50/60Hz) & A240(60Hz)=C2/C4
A240(50/60Hz)=C5/C6

 DC: D12(D1), D24(D2), D36(D3) & D48(D4)
other DC voltage as requested

 RAC: R110(50/60Hz) & R120(50/60Hz)=R1/R3
R220(60/60Hz) & R240(50/60Hz)=R2/R4
(W/Built-in rectifier, change AC into DC)

Spool type (see spool symbol chart)

Nominal size:

 02: 1/4"
03: 3/8"

Electrical conduit connection:

 A: Hirschmann/DIN type
B: Joint box type
C: Lead wire type

 DF: Wet type solenoid operated
directional valves

S: Shockless type

No code: Standard type

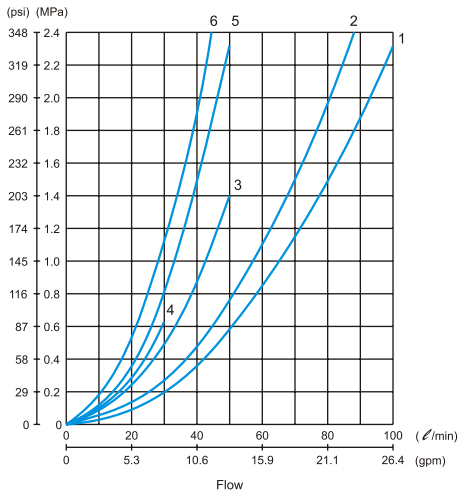
PERFORMANCE CURVE
Pressure drop characteristics

Model	Valve spool type	P→A	P→B	A→T	B→T	P→T
DFA-02 DFB-02 DFC-02 SERIES	2B8, 2B8L, 2D8	4	4	—	—	—
	2B2, 2B2L	2	2	2	2	—
	2D2	2	2	2	2	—
	2B3, 2B3L, 2D3	1	1	1	1	—
	3C3	1	1	1	1	1
	2B2B, 2B2BL, 3C2, 3C40	2	2	2	2	—
	3C12, 3C41	2	2	1	2	—
	3C11	1	2	2	2	—
	3C4	2	2	1	1	—
	3C60	6	6	5	5	3
3C5	1	6	2	5	3	
3C9	1	1	2	2	—	

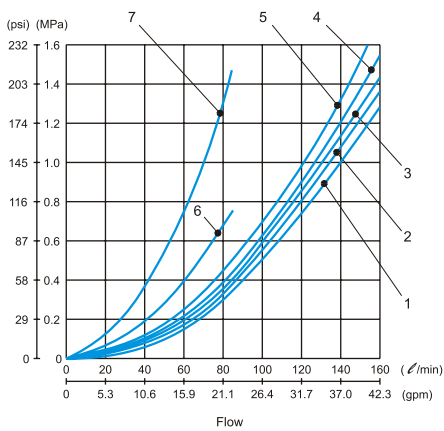
 Viscosity of hydraulic fluid 32 mm²/s {150 SUS}

Model	Valve spool type	P→A	P→B	A→T	B→T	P→T
DFA-03 DFB-03 DFC-03 SERIES	2B8, 2B8L, 2D8	5	5	—	—	—
	2B2B	—	3	3	—	—
	2B2BL	3	—	—	3	—
	2B2, 2B2L, 2D2	3	3	4	4	—
	2B3, 2B3L	1	1	4	4	—
	2D3	2	2	1	1	—
	3C12	3	3	1	3	—
	3C11	1	3	3	3	—
	3C3	1	1	1	1	1
	3C2, 3C41, 3C40	3	3	3	3	—
	3C4	3	3	1	1	—
	3C60	7	7	7	7	6
	3C5	1	7	1	7	6
3C9	1	1	3	3	—	

 Viscosity of hydraulic fluid 32 mm²/s {150 SUS}

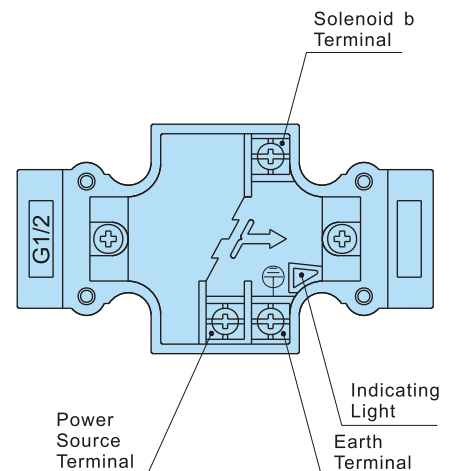
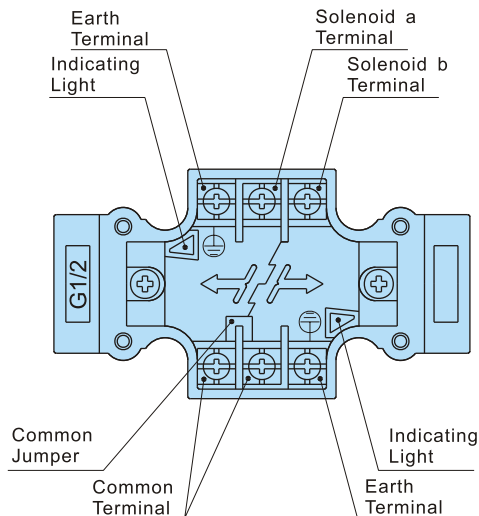
WIRING

Notice:

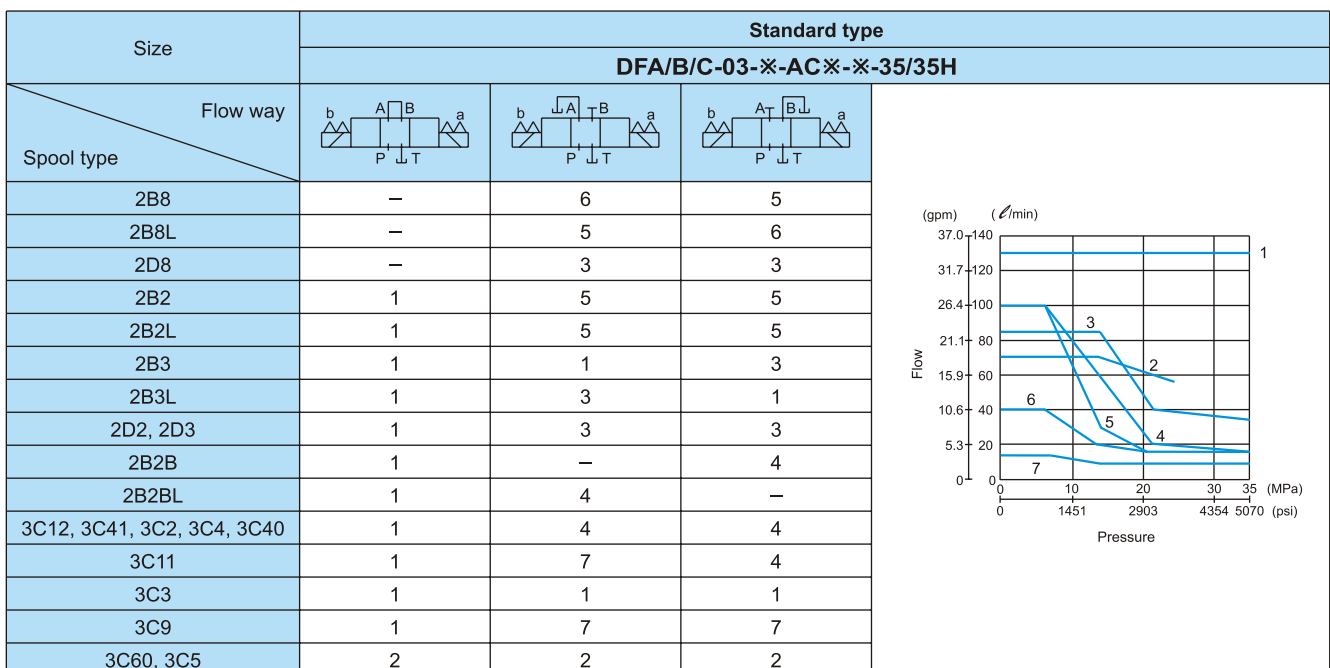
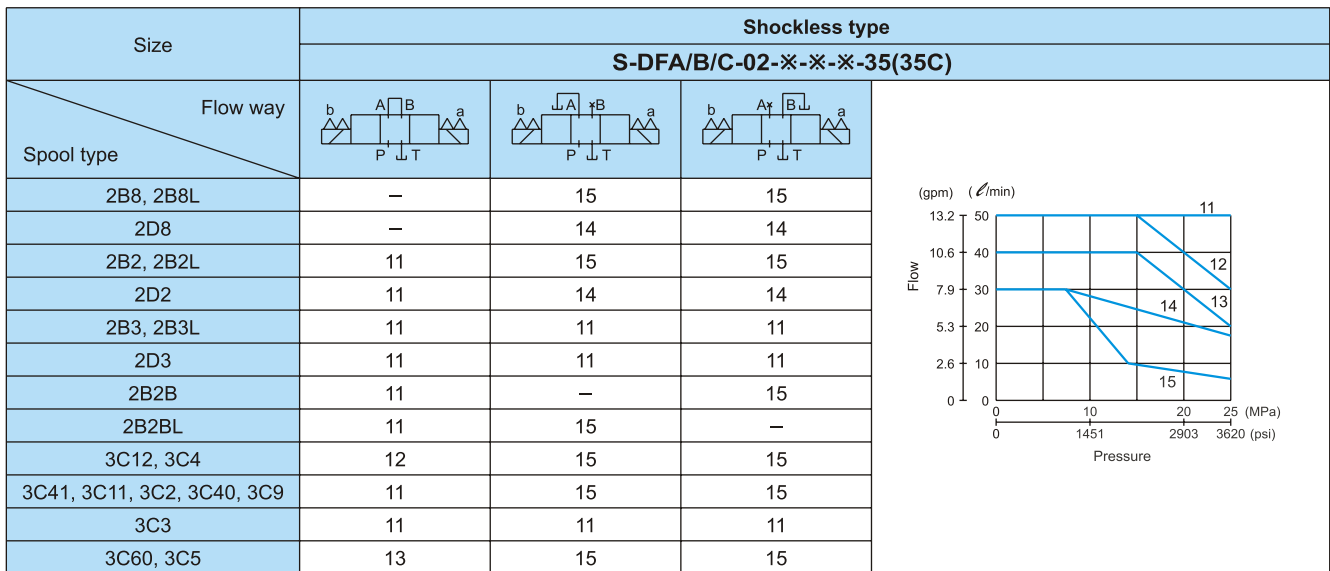
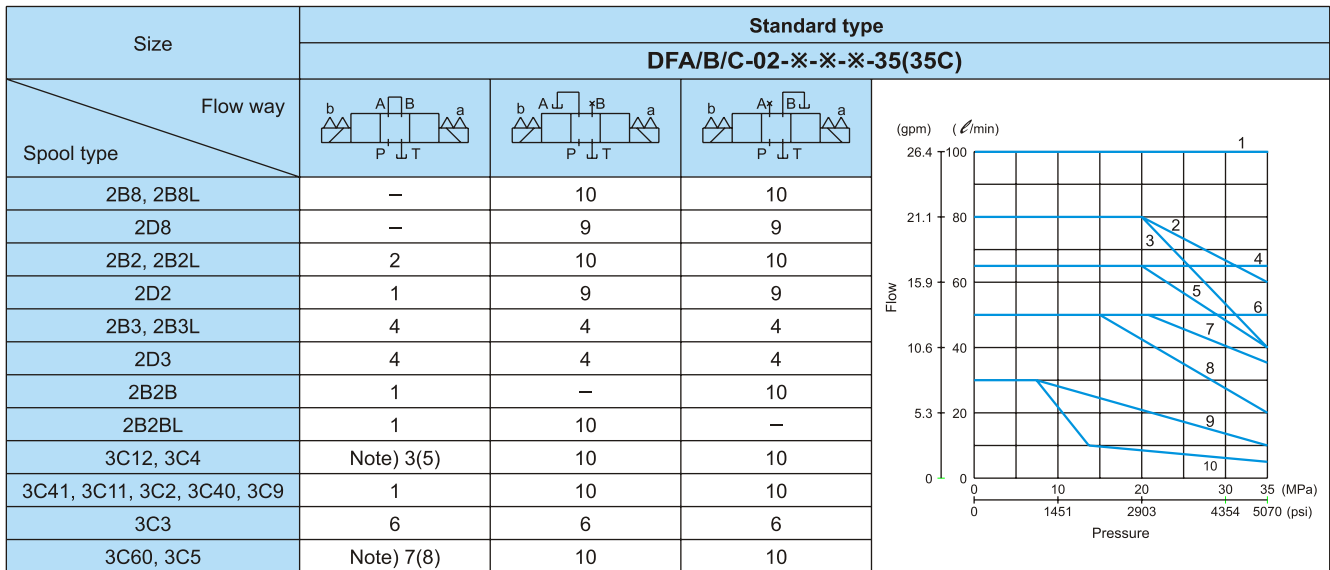
1. Either one of two earth terminals can be used when ground wiring is necessary.
2. Common Jumper can be dismantled when unnecessary.
3. When using direct current solenoid, No polarity concerned.

Pressure-Flow characteristics

Note) In the case of rectifier built-in type solenoid valve, pressure-flow characteristics becomes (5), (8).

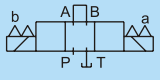
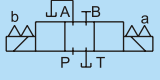
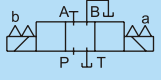
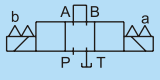
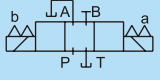
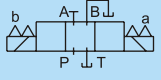
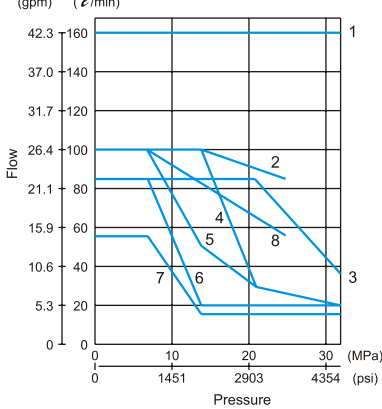
Pressure-Flow characteristics

Size	Standard type			Flow (gpm) (ℓ/min)
	DFA/B/C-03-※-DC※/RAC※-※-35/35H			
Flow way				Pressure (MPa) (psi)
Spool type				
2B8	—	5	6	
2B8L	—	6	5	
2D8	—	3	3	
2B2	1	4	6	
2B2L	1	6	4	
2B3	1	3	3	
2B3L	1	3	3	
2D2, 2D3	1	3	3	
2B2B	1	—	5	
2B2BL	1	5	—	
3C12, 3C41, 3C2, 3C4, 3C40	1	5	5	
3C11	1	7	5	
3C3	1	1	1	
3C9	1	7	7	
3C60, 3C5	Note) 2(8)	2(8)	2(8)	

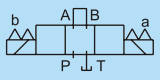
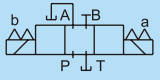
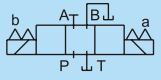
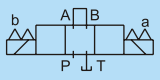
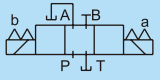
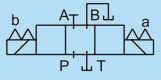
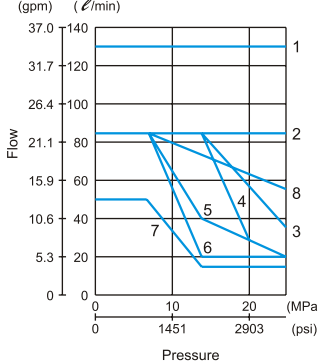
Size	Shockless type			Flow (gpm) (ℓ/min)
	S-DFA/B/C-03-※-DC※/RAC※-※-35/35H			
Flow way				Pressure (MPa) (psi)
Spool type				
2B8	—	5	6	
2B8L	—	6	5	
2D8	—	3	3	
2B2	1	4	6	
2B2L	1	6	4	
2B3	1	3	3	
2B3L	1	3	3	
2D2, 2D3	1	3	3	
2B2B	1	—	5	
2B2BL	1	5	—	
3C12, 3C41, 3C2, 3C4, 3C40	1	5	5	
3C11	1	7	5	
3C3	1	1	1	
3C9	1	7	7	
3C60, 3C5	Note) 2(8)	2(8)	2(8)	

Note) In the case of rectifier built-in type solenoid valve, pressure-flow characteristics becomes (8).

Installation Dimensions

mm(inch)

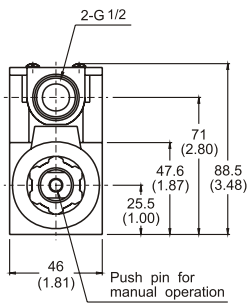
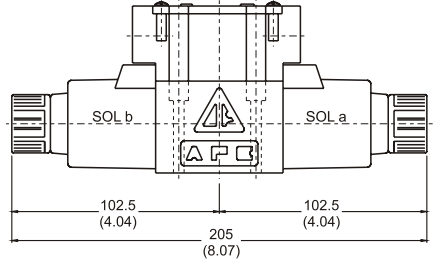
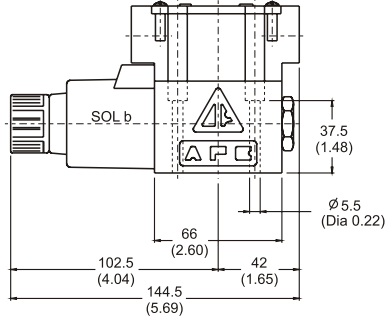
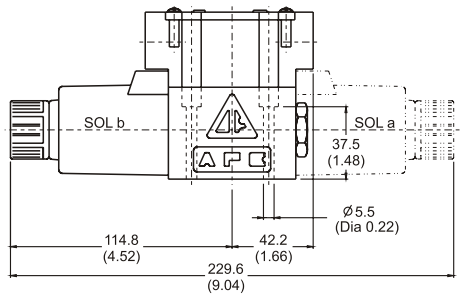
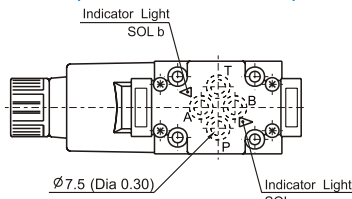
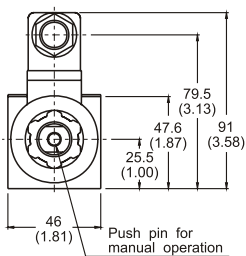
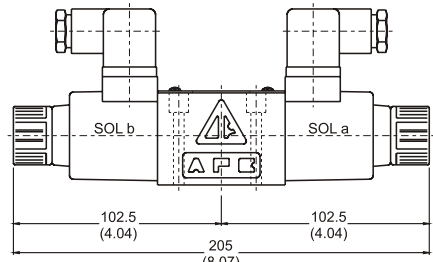
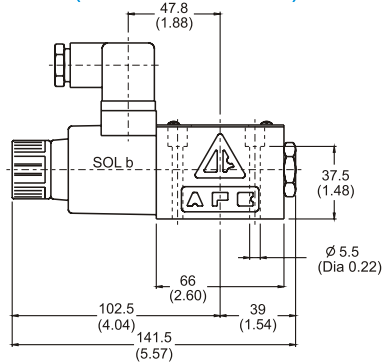
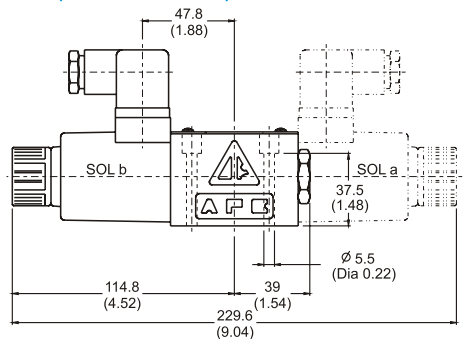
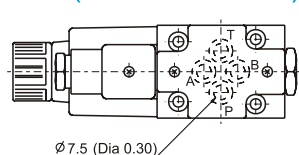
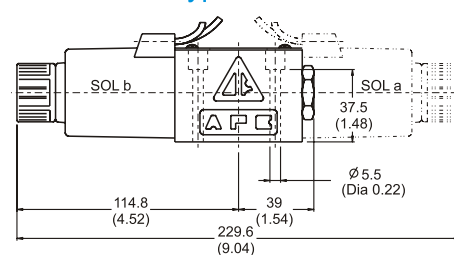
Joint Box Type
DFB-02-※-※-35(35C)
35 (AC solenoid)
35C (AC/DC solenoid)
35 (AC solenoid)
35C (AC/DC solenoid)

35 (AC solenoid)
35C (AC/DC solenoid)
35 (DC solenoid)

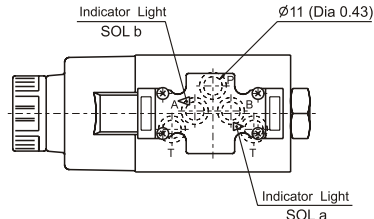
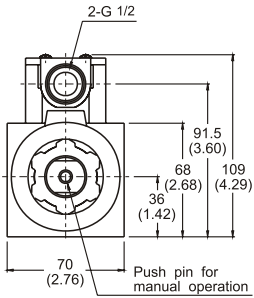
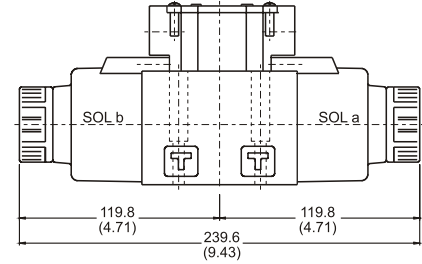
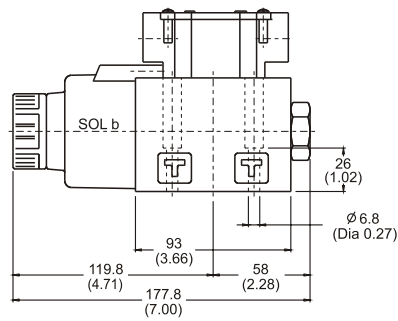
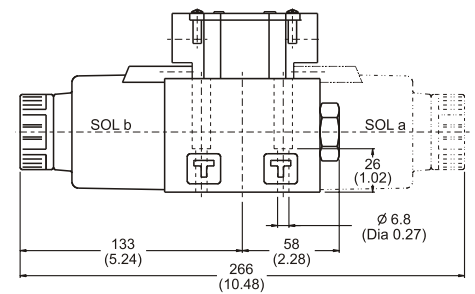
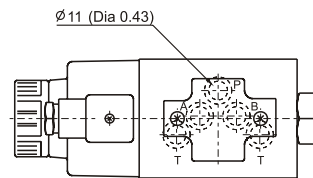
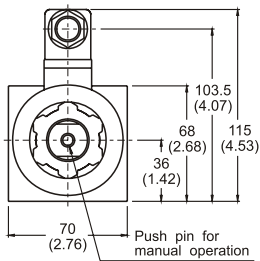
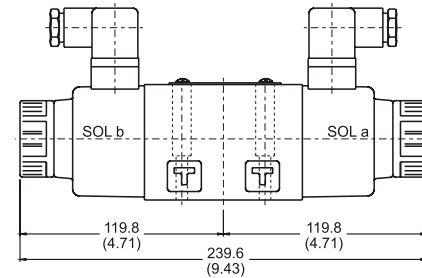
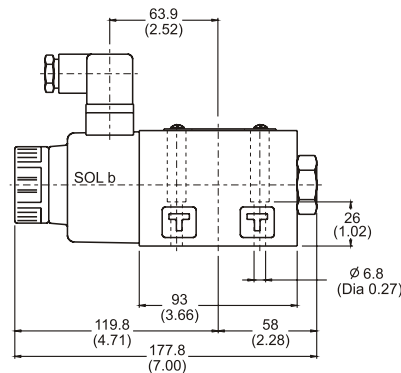
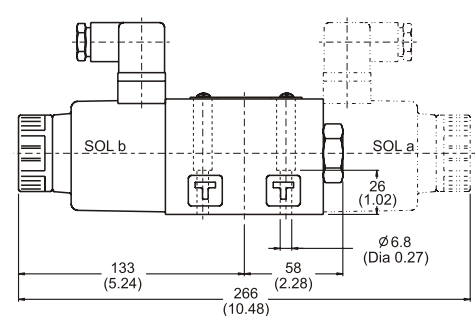
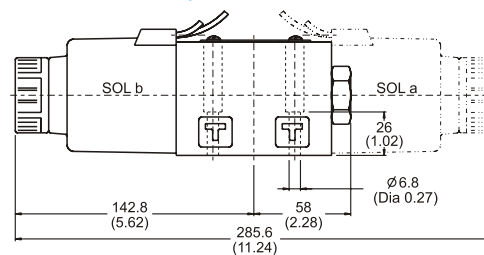
DIN Type
DFA-02-※-※-35(35C)
35 (AC solenoid)
35C (AC/DC solenoid)
35 (AC solenoid)
35C (AC/DC solenoid)

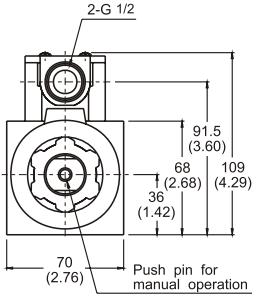
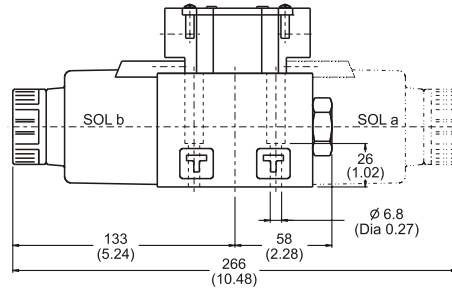
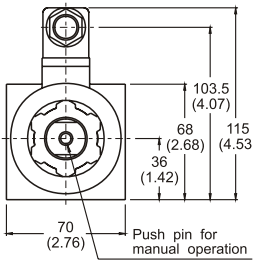
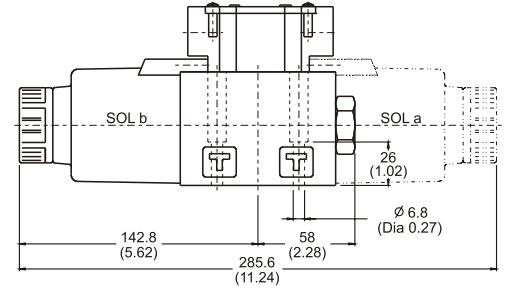
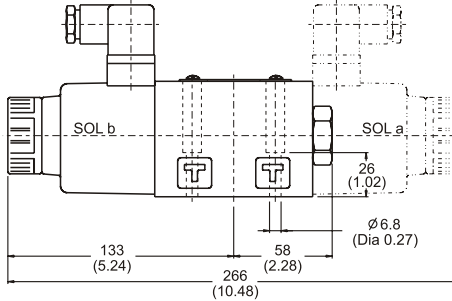
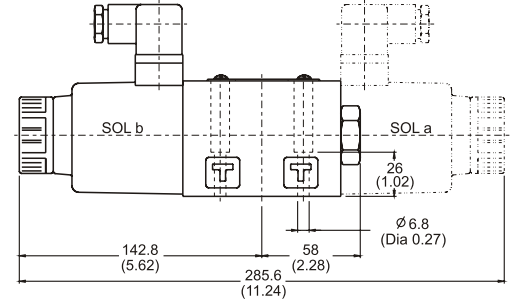
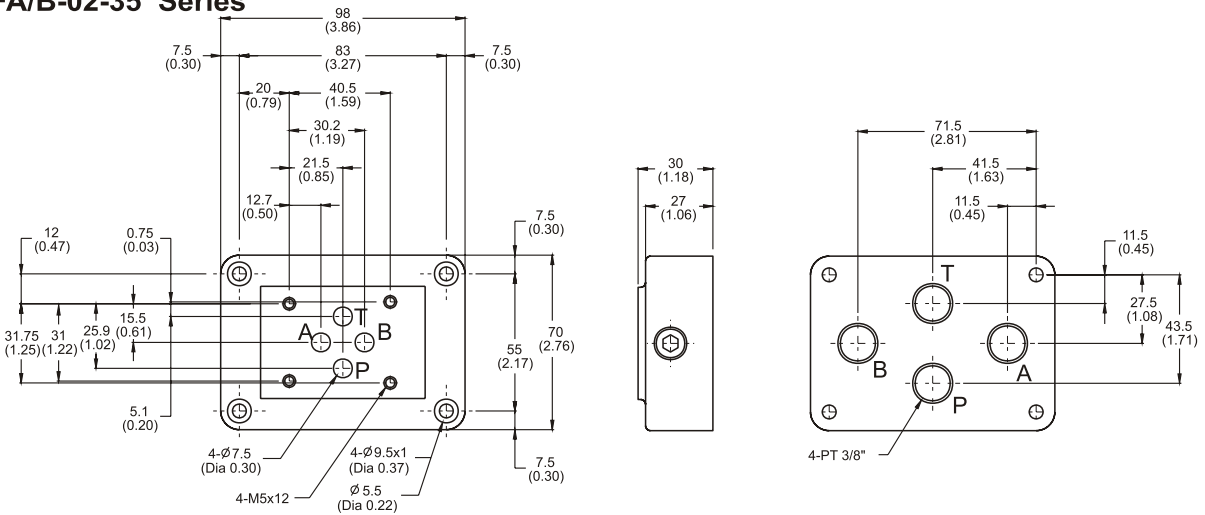
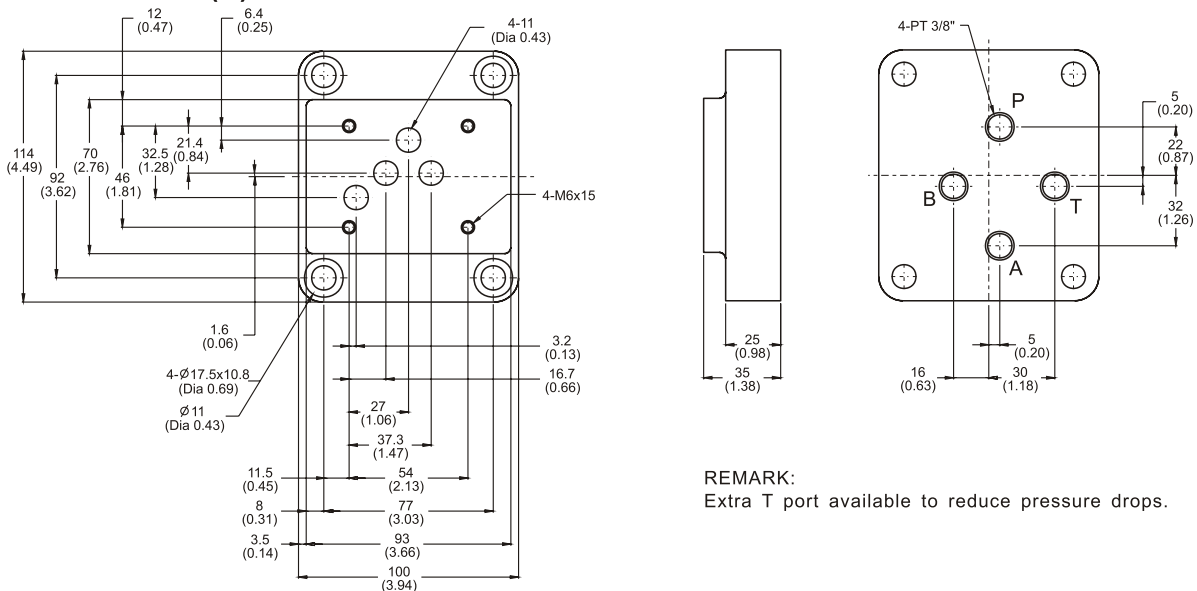
35 (AC solenoid)
35C (AC/DC solenoid)
35 (DC solenoid)

Lead Wire Type
DFC-02-※-※-35
Lead Wire Type

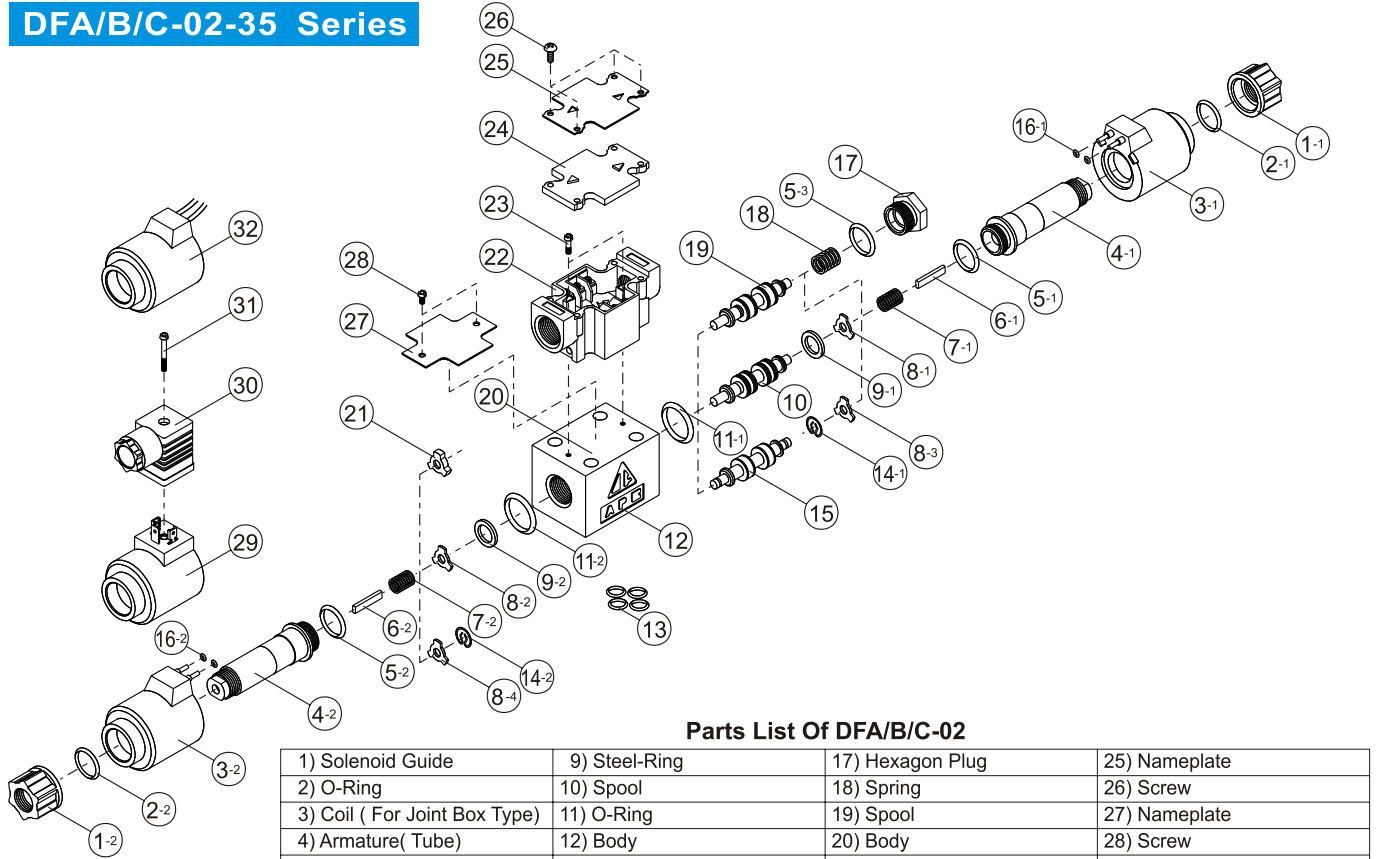
Installation Dimensions mm(inch)

**Joint Box Type
DFB-03-※-※-35**
AC solenoid

AC solenoid

AC solenoid

DC solenoid

**DIN Type
DFA-03-※-※-35**
AC solenoid

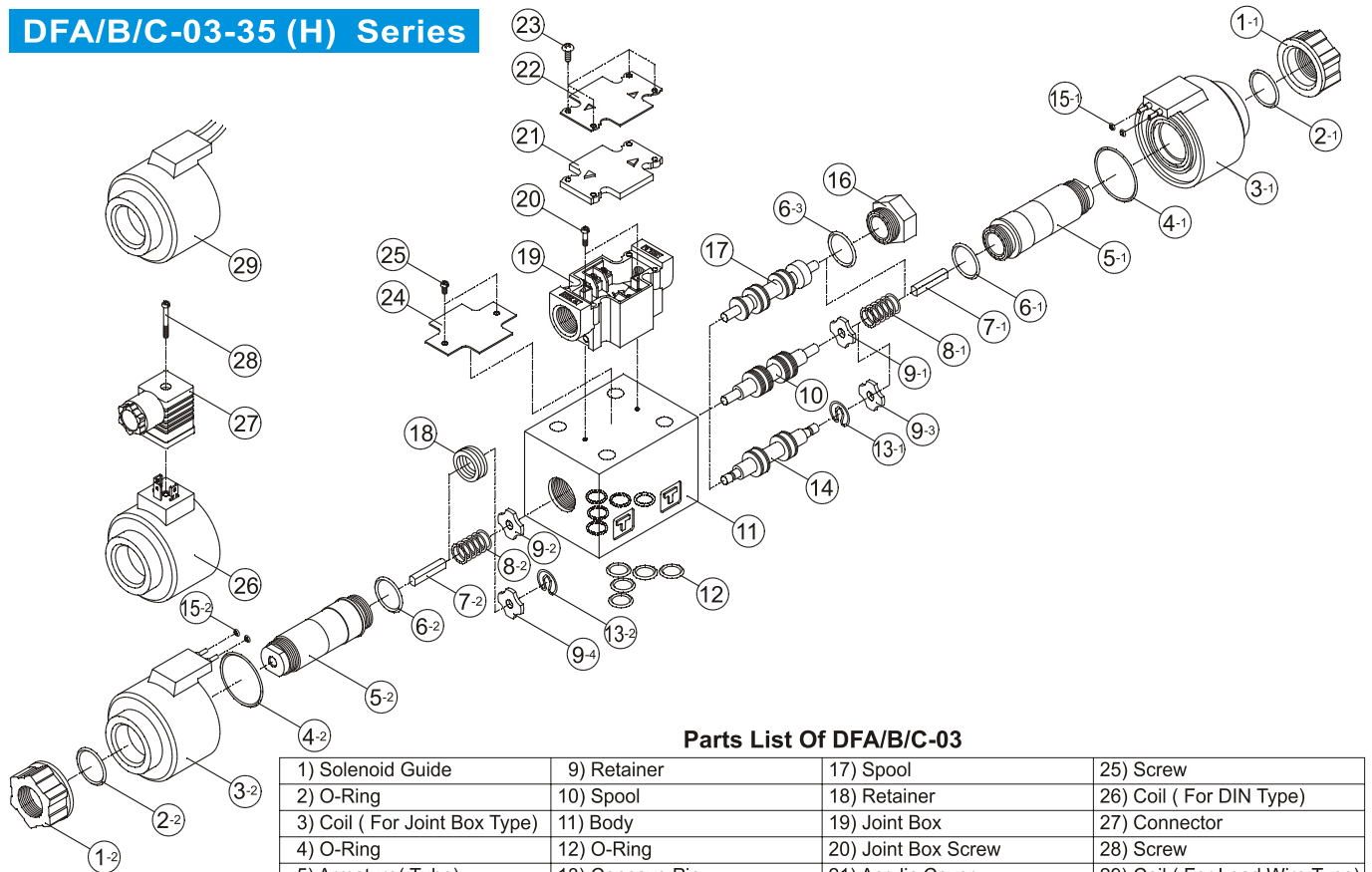
AC solenoid

AC solenoid

DC solenoid

**Lead Wire Type
DFC-03-※-※-35H**
Lead Wire Type

**Joint Box Type
DFB-03-※-※-35H**

AC solenoid

DC solenoid

AC solenoid

DC solenoid

SUBPLATE mm(inch)
For DFA/B-02-35 Series

For DFA/B-03-35(H) Series

REMARK:
Extra T port available to reduce pressure drops.

DFA/B/C-02-35 Series

Parts List Of DFA/B/C-02

1) Solenoid Guide	9) Steel-Ring	17) Hexagon Plug	25) Nameplate
2) O-Ring	10) Spool	18) Spring	26) Screw
3) Coil (For Joint Box Type)	11) O-Ring	19) Spool	27) Nameplate
4) Armature(Tube)	12) Body	20) Body	28) Screw
5) O-Ring	13) O-Ring	21) Retainer	29) Coil (For DIN Type)
6) Push Pin	14) Concave Pin	22) Joint Box	30) Connector
7) Spring	15) Spool	23) Screw	31) Screw
8) Retainer	16) O-Ring	24) Acrylic Cover	32) Coil (For Lead Wire Type)

DFA/B/C-03-35 (H) Series

Parts List Of DFA/B/C-03

1) Solenoid Guide	9) Retainer	17) Spool	25) Screw
2) O-Ring	10) Spool	18) Retainer	26) Coil (For DIN Type)
3) Coil (For Joint Box Type)	11) Body	19) Joint Box	27) Connector
4) O-Ring	12) O-Ring	20) Joint Box Screw	28) Screw
5) Armature(Tube)	13) Concave Pin	21) Acrylic Cover	29) Coil (For Lead Wire Type)
6) O-Ring	14) Spool	22) Nameplate	
7) Push Pin	15) O-Ring	23) Screw	
8) Spring	16) Hexagon Plug	24) Nameplate	